

# FJD5553

## NPN Silicon Transistor

### High Voltage Switch Mode Application

- Fast Speed Switching
- Wide Safe Operating Area
- Suitable for Electronic Ballast Application

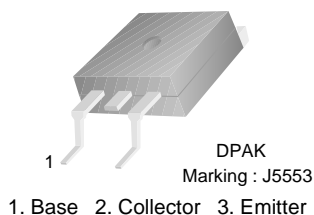

### Absolute Maximum Ratings \* $T_C=25^\circ\text{C}$ unless otherwise noted

Symbol	Parameter	Value	Units
$BV_{CBO}$	Collector-Base Voltage	1050	V
$BV_{CEO}$	Collector-Emitter Voltage	400	V
$BV_{EBO}$	Emitter-Base Voltage	14	V
$I_C$	Collector Current (DC)	3	A
$I_{CP}$	Collector Current (Pulse)	6	A
$I_B$	Base Current (DC)	1	A
$I_{BP}$	Collector Current (Pulse)	2	A
$P_C$	Collector Dissipation	1.25	W
$T_J$	Junction Temperature	150	$^\circ\text{C}$
$T_{STG}$	Storage Junction Temperature Range	- 55 ~ 150	$^\circ\text{C}$

\* These ratings are limiting values above which the serviceability of any semiconductor device may be impaired.

### Thermal Characteristics $T_a=25^\circ\text{C}$ unless otherwise noted

Symbol	Parameter	Value	Units
$R_{\theta JA}$	Thermal Resistance, Junction to Ambient	100	$^\circ\text{C}/\text{W}$

\* Device mounted on minimum pad size

### Ordering Information

Part Number	Marking	Package	Packing Method	Remarks
FJD5553TM	J5553	D-PAK	Tape & Reel	

**Electrical Characteristics** \*  $T_C=25^\circ\text{C}$  unless otherwise noted

Symbol	Parameter	Conditions	Min.	Typ.	Max	Units
$BV_{CBO}$	Collector-Base Breakdown Voltage	$I_C=500\mu\text{A}$ , $I_E=0$	1050			V
$BV_{CEO}$	Collector-Emitter Breakdown Voltage	$I_C=5\text{mA}$ , $I_B=0$	400			V
$BV_{EBO}$	Emitter-Base Breakdown Voltage	$I_E=500\mu\text{A}$ , $I_C=0$	14			V
$h_{FE}$	* DC Current Gain	$V_{CE}=5\text{V}$ , $I_C=10\text{mA}$	10			
		$V_{CE}=3\text{V}$ , $I_C=0.4\text{A}$	30		60	
$V_{CE}(\text{sat})$	Collector-Emitter Saturation Voltage	$I_C=1\text{A}$ , $I_B=0.2\text{A}$		0.23	0.5	V
$V_{BE}(\text{sat})$	Base-Emitter Saturation Voltage	$I_C=1\text{A}$ , $I_B=0.2\text{A}$			1.2	V
$C_{ob}$	Output Capacitance	$V_{CB}=10\text{V}$ , $f=1\text{MHz}$		45		pF
$t_{ON}$	Turn On Time	$V_{CC}=125\text{V}$ , $I_C=0.5\text{A}$ $I_{B1}=45\text{mA}$ , $I_{B2}=0.5\text{A}$ $R_L=250\Omega$			1.0	$\mu\text{s}$
$t_{STG}$	Storage Time				1.2	$\mu\text{s}$
$t_F$	Fall Time			0.3		$\mu\text{s}$
$t_{ON}$	Turn On Time	$V_{CC}=250\text{V}$ , $I_C=2.5\text{A}$ $I_{B1}=0.5\text{A}$ , $I_{B2}=1.0\text{A}$ $R_L=100\Omega$			2.0	$\mu\text{s}$
$t_{STG}$	Storage Time				2.5	$\mu\text{s}$
$t_F$	Fall Time				0.3	$\mu\text{s}$
EAS	Avalanche Energy	$L=2\text{mH}$	3.5			mJ

\* Pulse Test: Pulse Width $\leq 300\mu\text{s}$ , Duty Cycle $\leq 2\%$

# Typical Characteristics

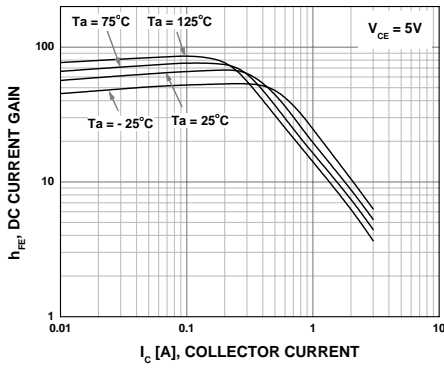

Figure 1. DC Current Gain

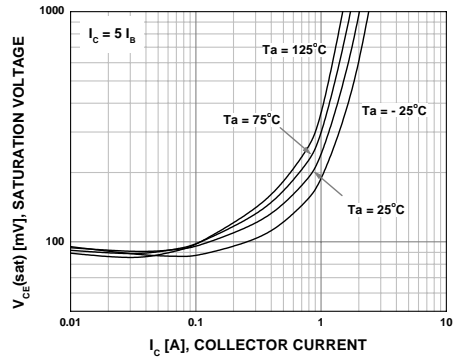

Figure 2. Saturation Voltage

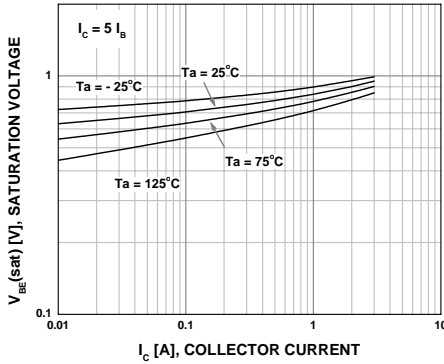

Figure 3. Saturation Voltage

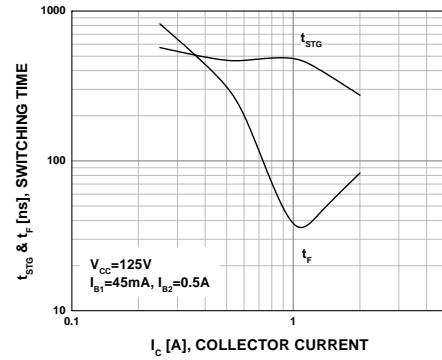

Figure 4. Resistive Load Switching

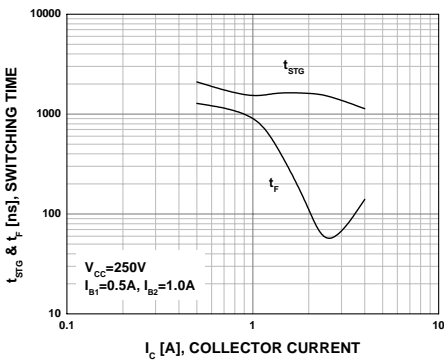

Figure 5. Resistive Load Switching

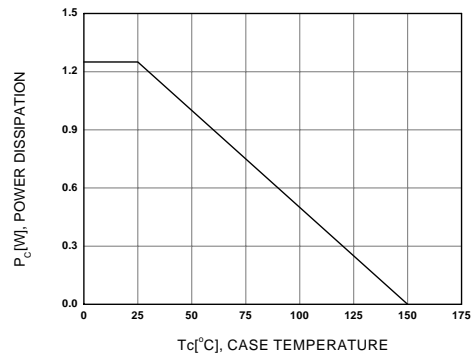
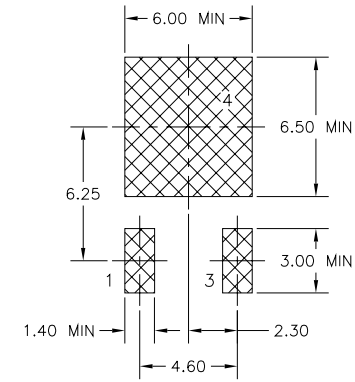
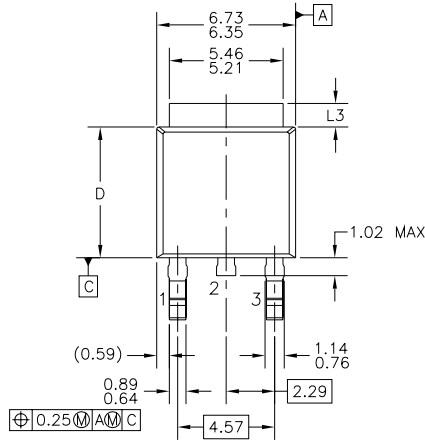

Figure 6. Power Derating

**Mechanical Dimensions**

**D-PAK**



LAND PATTERN RECOMMENDATION

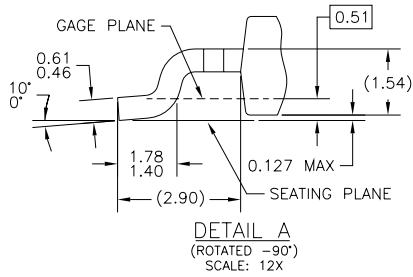
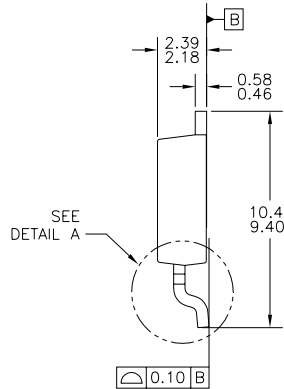
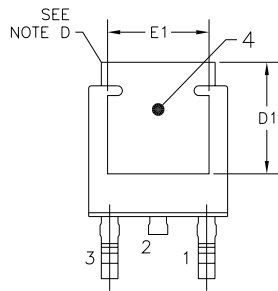

NOTES: UNLESS OTHERWISE SPECIFIED

- A) ALL DIMENSIONS ARE IN MILLIMETERS.
  - B) THIS PACKAGE CONFORMS TO JEDEC, TO-252, ISSUE C, VARIATION AA & AB, DATED NOV. 1999.
  - C) DIMENSIONING AND TOLERANCING PER ASME Y14.5M-1994.
  - D) HEAT SINK TOP EDGE COULD BE IN CHAMFERED CORNERS OR EDGE PROTRUSION.
  - E) DIMENSIONS L3,D,E1&D1 TABLE:
- |    | OPTION AA | OPTION AB |
|----|-----------|-----------|
| L3 | 0.89-1.27 | 1.52-2.03 |
| D  | 5.97-6.22 | 5.33-5.59 |
| E1 | 4.32 MIN  | 3.81 MIN  |
| D1 | 5.21 MIN  | 4.57 MIN  |
- F) PRESENCE OF TRIMMED CENTER LEAD IS OPTIONAL.

Dimensions in Millimeters



## TRADEMARKS

The following are registered and unregistered trademarks and service marks Fairchild Semiconductor owns or is authorized to use and is not intended to be an exhaustive list of all such trademarks.

ACEx <sup>®</sup>	Green FPS <sup>™</sup>	Power247 <sup>®</sup>	SuperSOT <sup>™</sup> -8
Build it Now <sup>™</sup>	Green FPS <sup>™</sup> e-Series <sup>™</sup>	POWEREDGE <sup>®</sup>	SyncFET <sup>™</sup>
CorePLUS <sup>™</sup>	GTO <sup>™</sup>	Power-SPM <sup>™</sup>	The Power Franchise <sup>®</sup>
CROSSVOLT <sup>™</sup>	<i>i-Lo</i> <sup>™</sup>	PowerTrench <sup>®</sup>	the power franchise <sup>®</sup>
CTL <sup>™</sup>	IntelliMAX <sup>™</sup>	Programmable Active Droop <sup>™</sup>	TinyBoost <sup>™</sup>
Current Transfer Logic <sup>™</sup>	ISOPLANAR <sup>™</sup>	QFET <sup>®</sup>	TinyBuck <sup>™</sup>
EcoSPARK <sup>®</sup>	MegaBuck <sup>™</sup>	QS <sup>™</sup>	TinyLogic <sup>®</sup>
<b>F</b> <sup>®</sup>	MICROCOUPLER <sup>™</sup>	QT Optoelectronics <sup>™</sup>	TINYOPTO <sup>™</sup>
Fairchild <sup>®</sup>	MicroFET <sup>™</sup>	Quiet Series <sup>™</sup>	TinyPower <sup>™</sup>
Fairchild Semiconductor <sup>®</sup>	MicroPak <sup>™</sup>	RapidConfigure <sup>™</sup>	TinyPWM <sup>™</sup>
FACT Quiet Series <sup>™</sup>	MillerDrive <sup>™</sup>	SMART START <sup>™</sup>	TinyWire <sup>™</sup>
FACT <sup>®</sup>	Motion-SPM <sup>™</sup>	SPM <sup>®</sup>	μSerDes <sup>™</sup>
FAST <sup>®</sup>	OPTOLOGIC <sup>®</sup>	STEALTH <sup>™</sup>	UHC <sup>®</sup>
FastvCore <sup>™</sup>	OPTOPLANAR <sup>®</sup>	SuperFET <sup>™</sup>	UniFET <sup>™</sup>
FPS <sup>™</sup>	 <sup>®</sup>	SuperSOT <sup>™</sup> -3	VCX <sup>™</sup>
FRFET <sup>®</sup>	PDP-SPM <sup>™</sup>	SuperSOT <sup>™</sup> -6	
Global Power Resource <sup>SM</sup>	Power220 <sup>®</sup>		

## DISCLAIMER

FAIRCHILD SEMICONDUCTOR RESERVES THE RIGHT TO MAKE CHANGES WITHOUT FURTHER NOTICE TO ANY PRODUCTS HEREIN TO IMPROVE RELIABILITY, FUNCTION, OR DESIGN. FAIRCHILD DOES NOT ASSUME ANY LIABILITY ARISING OUT OF THE APPLICATION OR USE OF ANY PRODUCT OR CIRCUIT DESCRIBED HEREIN; NEITHER DOES IT CONVEY ANY LICENSE UNDER ITS PATENT RIGHTS, NOR THE RIGHTS OF OTHERS. THESE SPECIFICATIONS DO NOT EXPAND THE TERMS OF FAIRCHILD'S WORLDWIDE TERMS AND CONDITIONS, SPECIFICALLY THE WARRANTY THEREIN, WHICH COVERS THESE PRODUCTS.

## LIFE SUPPORT POLICY

FAIRCHILD'S PRODUCTS ARE NOT AUTHORIZED FOR USE AS CRITICAL COMPONENTS IN LIFE SUPPORT DEVICES OR SYSTEMS WITHOUT THE EXPRESS WRITTEN APPROVAL OF FAIRCHILD SEMICONDUCTOR CORPORATION.

As used herein:

- Life support devices or systems are devices or systems which, (a) are intended for surgical implant into the body, or (b) support or sustain life, and (c) whose failure to perform when properly used in accordance with instructions for use provided in the labeling, can be reasonably expected to result in significant injury to the user.
- A critical component is any component of a life support device or system whose failure to perform can be reasonably expected to cause the failure of the life support device or system, or to affect its safety or effectiveness.

## PRODUCT STATUS DEFINITIONS

### Definition of Terms

Datasheet Identification	Product Status	Definition
Advance Information	Formative or In Design	This datasheet contains the design specifications for product development. Specifications may change in any manner without notice.
Preliminary	First Production	This datasheet contains preliminary data; supplementary data will be published at a later date. Fairchild Semiconductor reserves the right to make changes at any time without notice to improve design.
No Identification Needed	Full Production	This datasheet contains final specifications. Fairchild Semiconductor reserves the right to make changes at any time without notice to improve design.
Obsolete	Not In Production	This datasheet contains specifications on a product that has been discontinued by Fairchild semiconductor. The datasheet is printed for reference information only.